



ΚΕΝΤΡΙΚΗ ΔΙΑΘΕΣΗ : ΑΡΙΣΤΟΓΕΙΤΟΝΟΣ 7 - ΣΟΦΟΚΛΕΟΥΣ 4, ΚΑΛΛΙΘΕΑ 176 71, ΑΘΗΝΑ, ΤΗΛ. 210 9576382, FAX 210 9576473
HEAD OFFICE : 7, ΑΡΙΣΤΟΓΙΤΟΝΟΣ str. - 4, ΣΟΦΟΚΛΕΟΥΣ str., ΚΑΛΛΙΘΕΑ 176 71, ATHENS-GREECE, TEL. +30210 9576382, FAX +30210 9576473

ΕΡΓΟΣΤΑΣΙΟ : ΑΠΟΛΛΩΝΙΟΥ 6, ΚΟΡΩΠΙ 194 00, ΑΤΤΙΚΗ, ΤΗΛ 210 6620400 FAX 210 6620401
FACTORY : 6, ΑΠΟΛΛΟΝΙΟΥ str., ΚΟΡΩΠΙ 194 00, ΑΤΤΙΚΑ-GREECE, TEL. +30210 6620400 FAX +30210 6620401

Web Site: www.inal.gr E-mail: intermetal@inal.gr

*provail graphic arts www.provail.com



Edition 2004 / Code IPMS 72004



Περιεχόμενα

• ΣΤΗΡΙΓΜΑΤΑ PLANISPHERE (PLR) ΕΠΙΠΕΔΗΣ ΕΔΡΑΣΗΣ PLANISPHERE SUPPORTS (PLR)	ΣΕΛ. 4
• ΣΦΙΚΤΗΡΕΣ PLR ΚΡΥΣΤΑΛΛΩΝ FIXED AND ARTICULATED HEADS PLR	ΣΕΛ. 8
• ΣΥΝΔΥΑΣΜΟΙ ΚΑΤΑΣΚΕΥΩΝ MINOX MINOX ACCESSORIES COMBINATIONS	ΣΕΛ. 10
• ΣΤΕΓΑΝΩΤΙΚΑ & ΒΟΗΘΗΤΙΚΑ ΥΛΙΚΑ ΚΑΤΑΣΚΕΥΩΝ ΜΕ PLR WEATHER PROOFING & ADDITIONAL ACCESSORIES FOR PLR CONSTRUCTIONS	ΣΕΛ. 18
• ΤΕΧΝΙΚΕΣ ΛΕΠΤΟΜΕΡΕΙΕΣ TECHNICAL DETAILS	ΣΕΛ. 20



HILTON ATHENS



ΣΤΗΡΙΓΜΑΤΑ PLANISPHERE ΕΠΙΠΕΔΗΣ ΕΔΡΑΣΗΣ
PLANISPHERE SUPPORTS



ΣΗΜΕΙΩΣΗ / NOTE

PLR 150mm - L:36
PLR 200mm - L:38
PLR 250mm - L:40

ΣΤΗΡΙΓΜΑ 4 ΣΗΜΕΙΩΝ
4 ARMS SUPPORT

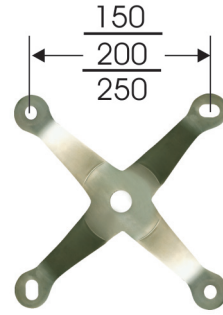

ΚΩΔΙΚΟΣ / CODE

- 304.15** 150mm - Πάχος / Thickness 6mm
- 304.20** 200mm - Πάχος / Thickness 8mm
- 304.25** 250mm - Πάχος / Thickness 10mm

ΣΤΗΡΙΓΜΑ 3 ΣΗΜΕΙΩΝ
3 ARMS SUPPORT

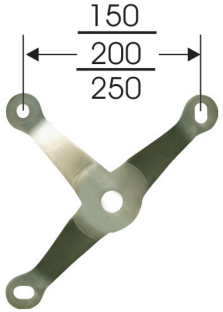

ΚΩΔΙΚΟΣ / CODE

- 303.15** 150mm - Πάχος / Thickness 6mm
- 303.20** 200mm - Πάχος / Thickness 8mm
- 303.25** 250mm - Πάχος / Thickness 10mm

ΣΤΗΡΙΓΜΑ 2 ΣΗΜΕΙΩΝ
2 ARMS SUPPORT

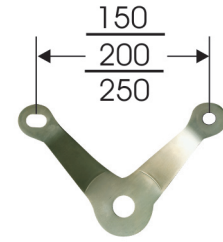

ΚΩΔΙΚΟΣ / CODE

- 302.15** 150mm - Πάχος / Thickness 6mm
- 302.20** 200mm - Πάχος / Thickness 8mm
- 302.25** 250mm - Πάχος / Thickness 10mm

ΣΤΗΡΙΓΜΑ 1 ΣΗΜΕΙΟΥ
1 ARM SUPPORT

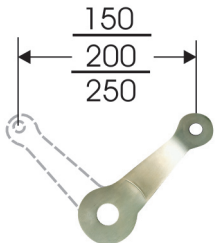

ΚΩΔΙΚΟΣ / CODE

- 301.15** 150mm - Πάχος / Thickness 6mm
- 301.20** 200mm - Πάχος / Thickness 8mm
- 301.25** 250mm - Πάχος / Thickness 10mm

ΣΤΗΡΙΓΜΑ 2 ΣΗΜΕΙΩΝ ΣΕ ΕΥΘΕΙΑ
2 ARMS STRAIGHT SUPPORT

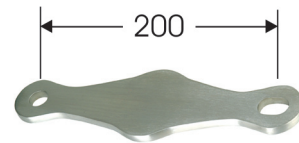

ΚΩΔΙΚΟΣ / CODE

- 308.20** 200mm - Πάχος / Thickness 8mm

ΚΩΔ./CODE 310-08

ΤΑΠΑ PLR (ΦΡΕΖΑΤΗ) Φ30-M8
CONE HEAD PLR Φ30-M8

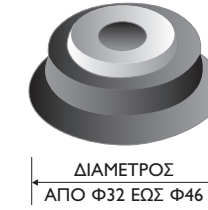

Φ32 - M8 - L10
Φ46 - M10 - L12
Φ46 - M12 - L14
Φ46 - M14 - L14

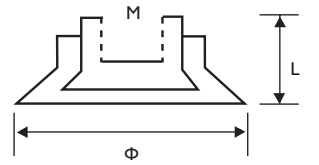

ΚΩΔ./CODE 310-07

ΤΑΠΑ PLR Φ40-M14
FLAT HEAD PLR Φ40-M14

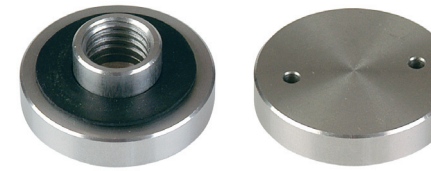

Φ30 - M8 - L10
Φ40 - M10 - L12
Φ40 - M12 - L14
Φ40 - M14 - L14

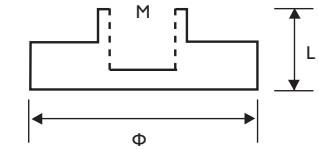

ΚΩΔ./CODE 310-01

ΡΟΔΕΛΛΕΣ PLR ΣΦΑΙΡΙΚΗΣ ΕΔΡΑΣΗΣ
PLR RINGS FOR SPHERICAL SUPPORT

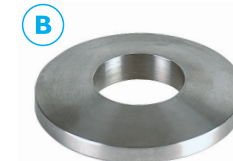
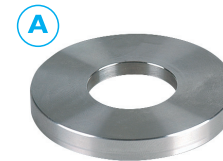

ΚΩΔ./CODE 310-02

ΚΕΝΤΡΙΚΗ ΣΤΗΡΙΞΗ PLR Φ70-M16
FIXING POINT PLR M16



ΚΩΔ./CODE 310-03

ΡΟΔΕΛΛΑ M16
ΚΕΝΤΡΙΚΗΣ
ΣΤΗΡΙΞΗΣ
CENTRAL
SUPPORT
M16 RING



ΚΩΔ./CODE 310-09

ΡΟΔΕΛΛΕΣ
INOX
Φ30 ΕΩΣ Φ40
INOX RINGS
Φ30-Φ40

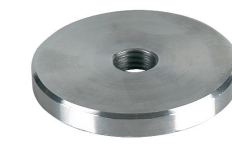

ΕΦΑΡΜΟΓΗ **PLR** ΓΙΑ ΥΑΛΟΣΤΑΣΙΑ ΜΕ ΑΝΤΙΡΙΔΑ / **PLR** APPLICATION

ΚΩΔ./CODE 307 ΣΤΗΡΙΓΜΑ **PLR** ΔΥΟ ΣΗΜΕΙΩΝ ΑΝΤΙΡΙΔΑ
TWO ARMS SUPPORT TO ROD (GLASS OR METAL)

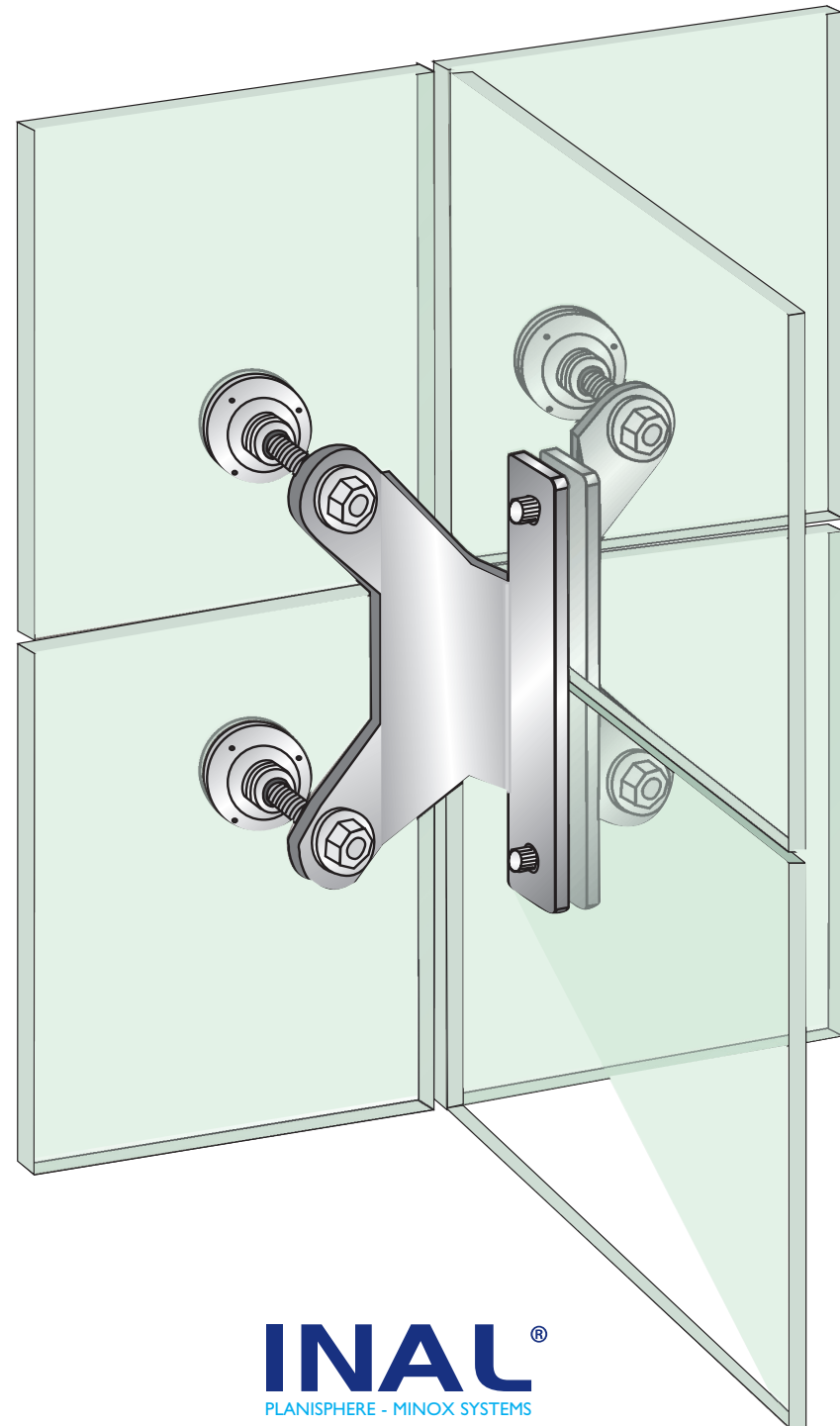

INAL[®]
PLANISPHERE - MINOX SYSTEMS



ΛΕΠΤΟΜΕΡΕΙΑ ΓΩΝΙΑΚΗΣ ΟΡΘΟΚΡΥΣΤΑΛΛΩΣΗΣ / DETAIL OF ANGLE (90°) GLASS FITTING

ΚΩΔ./CODE 305 ΣΤΗΡΙΓΜΑ **PLR** ΓΩΝΙΑΚΟ Γ-Γ 90°
90° ANGLE SUPPORT GLASS-GLASS

Η παρακάτω εφαρμογή ισχύει
για γυαλί 12mm έως 20mm.
The following application
is valid for glass 12mm to 20mm.

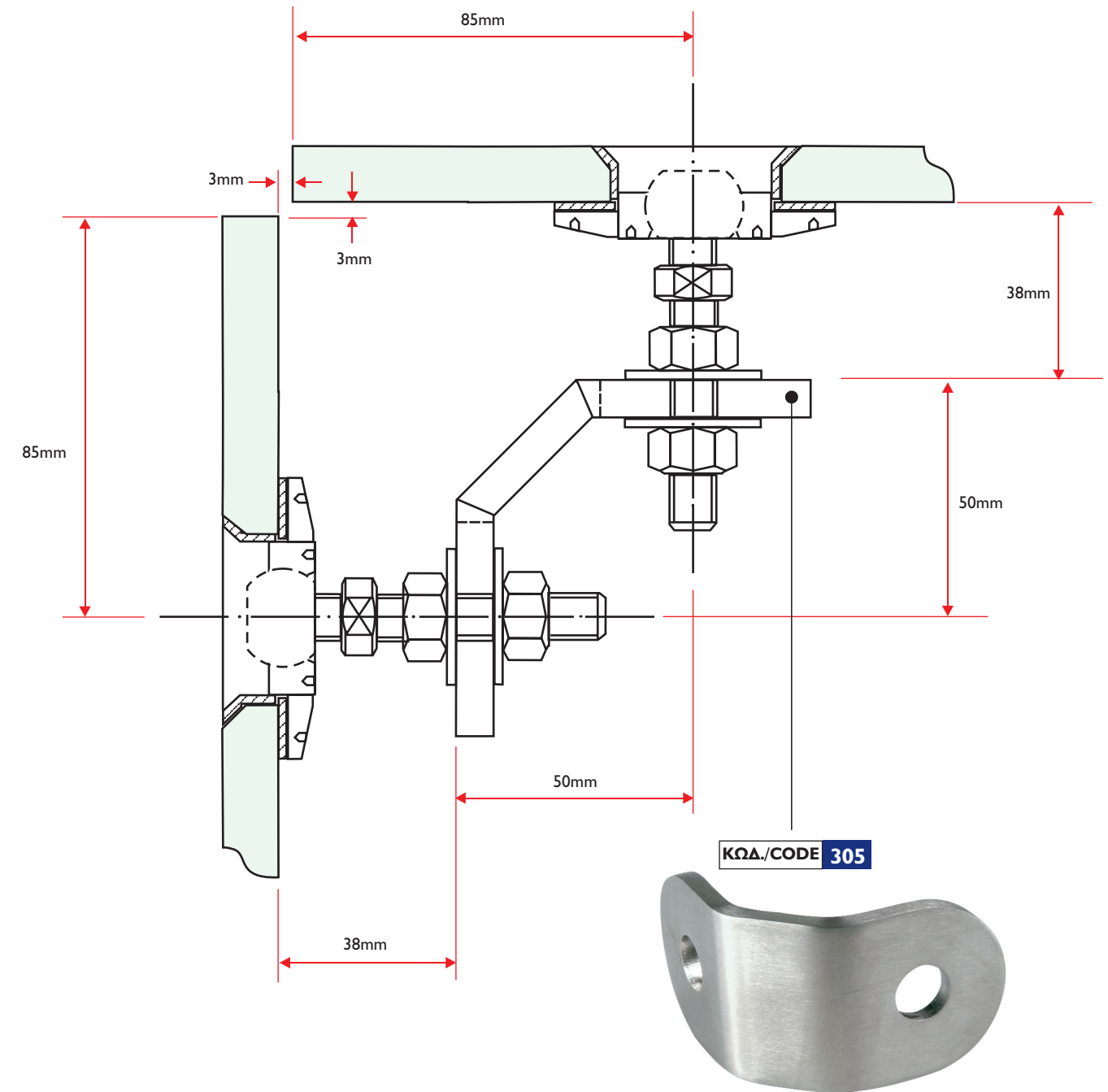

ΣΤΑΘΕΡΗ ΚΕΦΑΛΗ **PLR** Φ60-M14 / FIXED FLAT HEAD PLR Φ60-M14

ΚΩΔ./CODE **311**

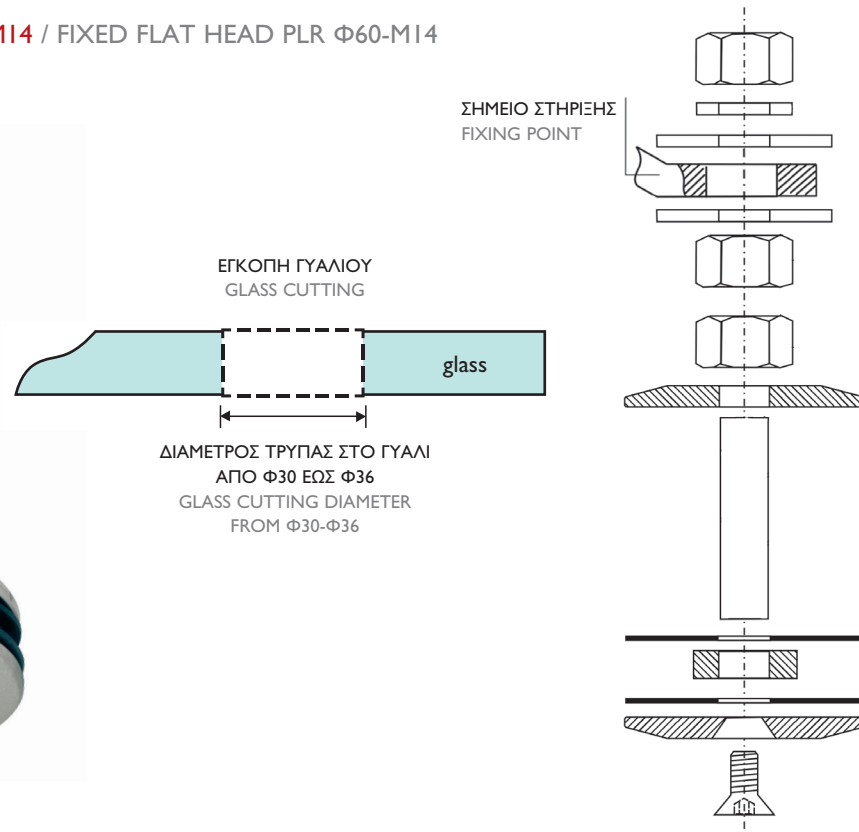

ΕΠΙΠΕΔΗ ΑΡΘΡΩΤΗ ΚΕΦΑΛΗ **PLR** / ARTICULATED FLAT HEAD PLR

ΚΩΔ./CODE **312**

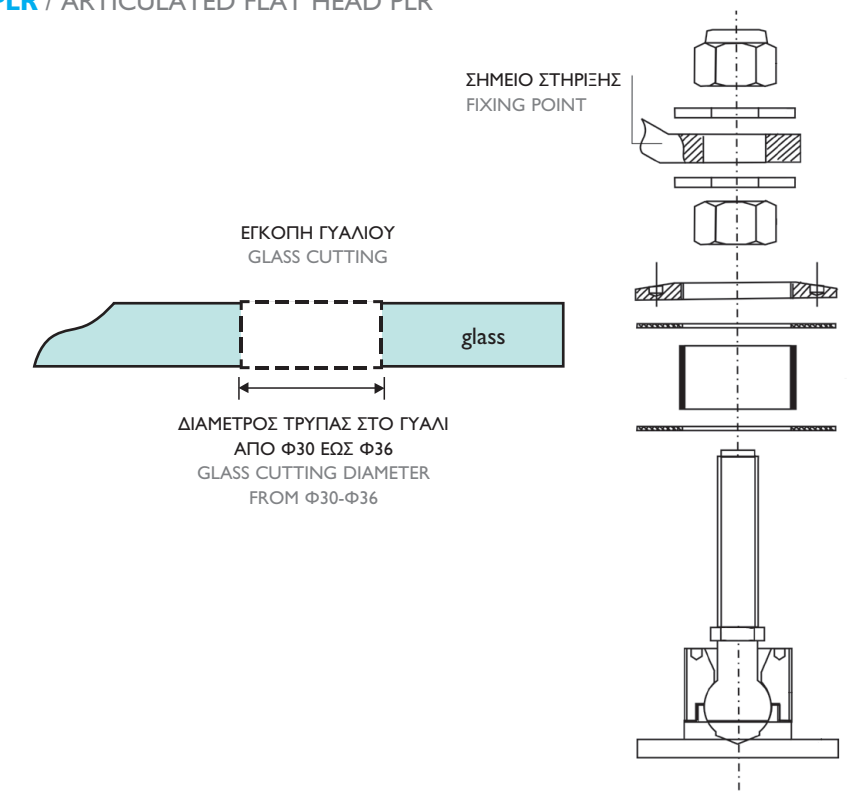

ΣΤΑΘΕΡΗ ΚΕΦΑΛΗ **PLR** Φ40K-M14 / FIXED FLAT HEAD PLR Φ40K-M14

ΚΩΔ./CODE **314**

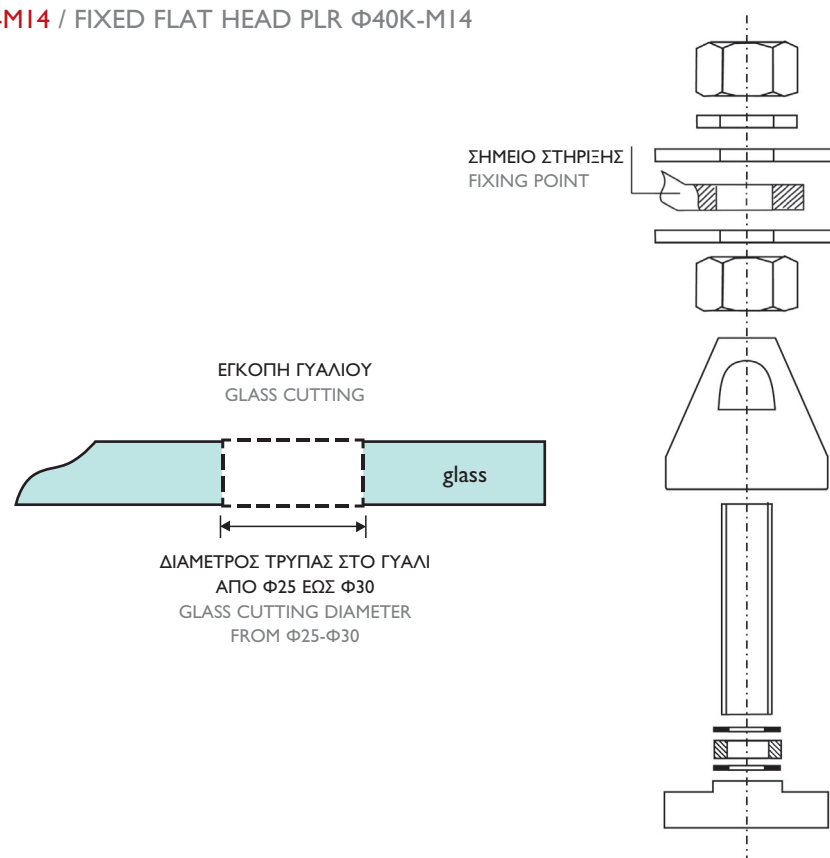

ΚΩΝΙΚΗ ΑΡΘΡΩΤΗ ΚΕΦΑΛΗ **PLR** / ARTICULATED CONE HEAD PLR

ΚΩΔ./CODE **313**

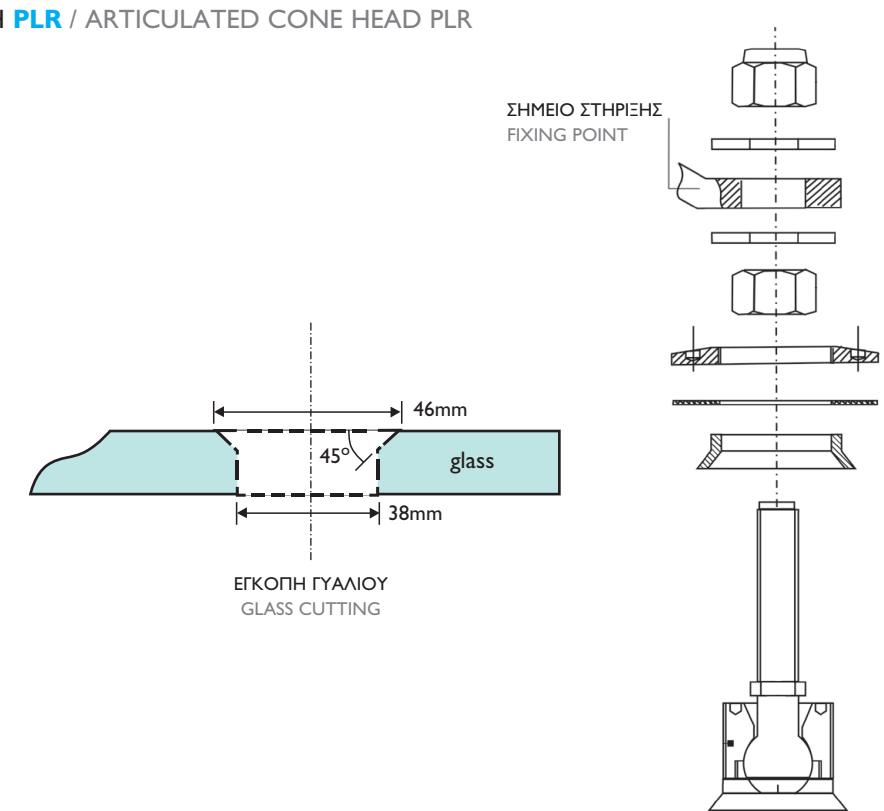

ΜΠΡΑΚΕΤΟ ΔΙΔΥΜΟ ΚΩΝΙΚΟ **MINOX** / DOUBLE CONE BRACKET - MINOX

ΚΩΔ./CODE **321**

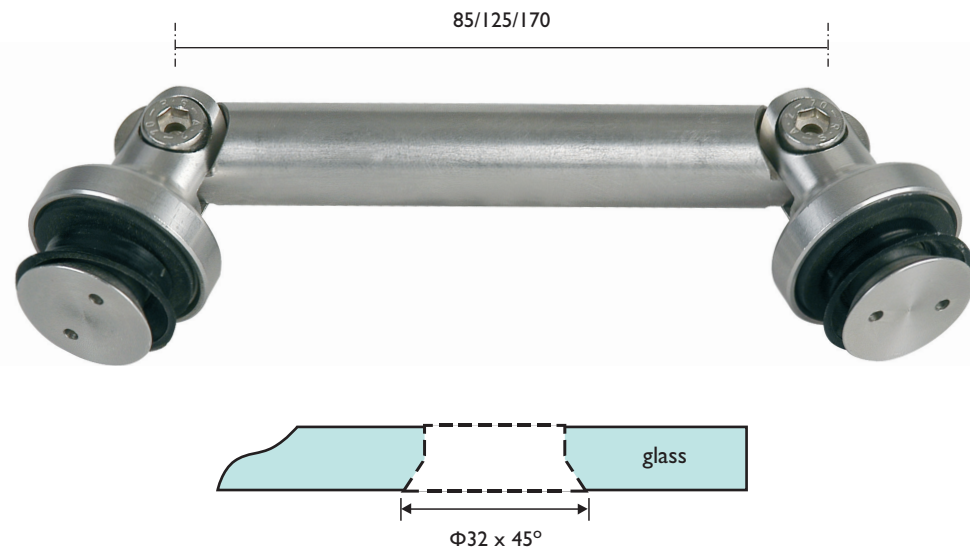

ΚΩΔΙΚΟΣ / CODE

- 321.85** Φ20 x L85
- 321.125** Φ20 x L125
- 321.170** Φ20 x L170

Για γυαλί
8mm έως 15mm.
For 8-15mm glass.

ΜΠΡΑΚΕΤΟ ΔΙΔΥΜΟ Φ60 **MINOX** / DOUBLE BRACKET Φ60 - MINOX

ΚΩΔ./CODE **322**

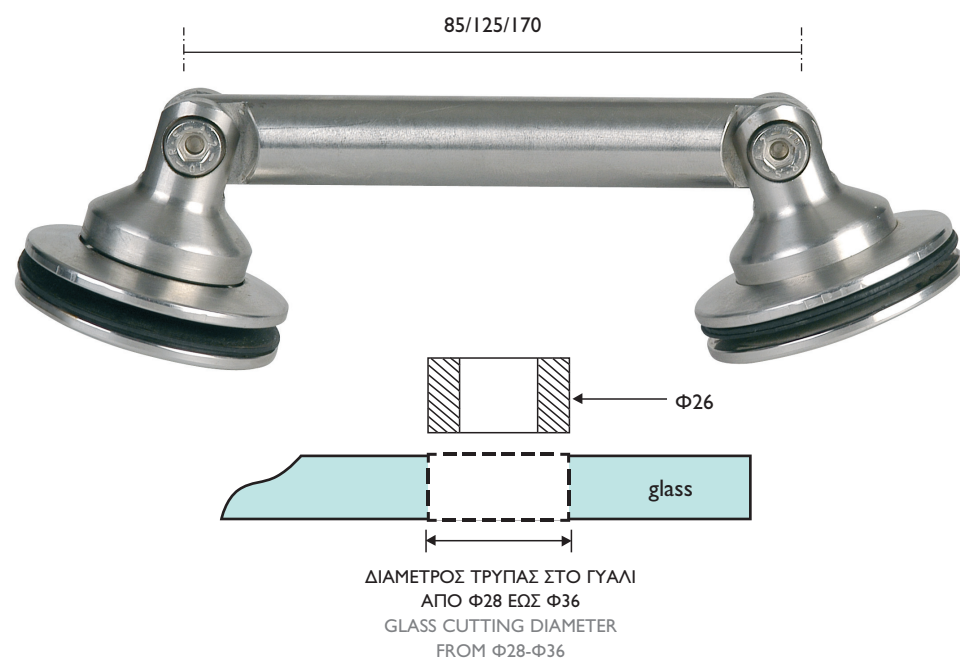

ΚΩΔΙΚΟΣ / CODE

- 322.85** Φ20 x L85
- 322.125** Φ20 x L125
- 322.170** Φ20 x L170

Για γυαλί
8mm έως 15mm.
For 8-15mm glass.



ΜΠΡΑΚΕΤΟ ΜΟΝΟ ΤΟΙΧΟΥ ΚΩΝΙΚΟ-170mm
SINGLE GLASS-WALL CONE BRACKET-170mm

ΚΩΔ./CODE **323.170**



ΜΠΡΑΚΕΤΟ ΜΟΝΟ ΤΟΙΧΟΥ Φ60-170mm
SINGLE GLASS-WALL FLAT Φ60 BRACKET-170mm

ΚΩΔ./CODE **324.170**



ΚΩΔ./CODE **323**



ΜΠΡΑΚΕΤΟ ΜΟΝΟ ΤΟΙΧΟΥ ΚΩΝΙΚΟ ΜΕ ΑΝΤΙΠΙΔΑ

SINGLE GLASS-WALL CONE BRACKET

ΚΩΔ./CODE **324**

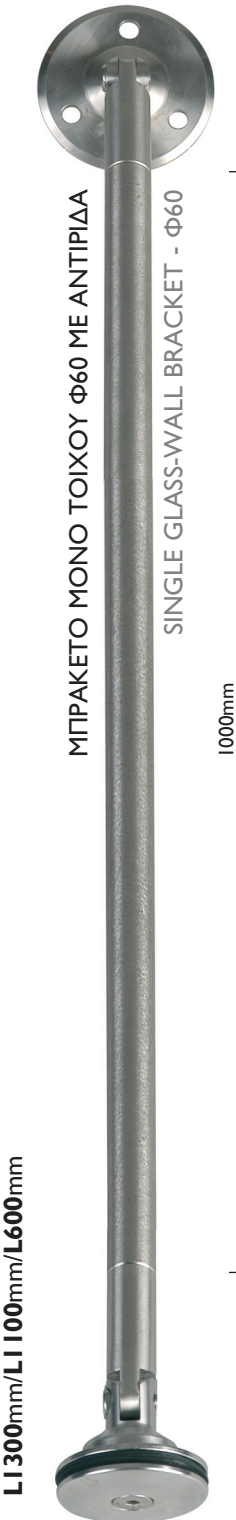

ΜΠΡΑΚΕΤΟ ΜΟΝΟ ΤΟΙΧΟΥ Φ60 ΜΕ ΑΝΤΙΠΙΔΑ

SINGLE GLASS-WALL BRACKET - Φ60

1000mm

Ρυθμιζόμενο μήκος/Adjustable length
L1300mm/LI 100mm/L600mm

ΜΠΡΑΚΕΤΟ ΔΙΠΛΟ ΤΟΙΧΟΥ ΚΩΝΙΚΟ-170mm
DOUBLE GLASS-WALL CONE BRACKET-170mm

ΚΩΔ./CODE **325.170**



ΜΠΡΑΚΕΤΟ ΔΙΠΛΟ ΤΟΙΧΟΥ Φ60-170mm
DOUBLE GLASS-WALL FLAT Φ60 BRACKET-170mm

ΚΩΔ./CODE **326.170**



ΚΩΔ./CODE **325**

ΜΠΡΑΚΕΤΟ ΔΙΠΛΟ ΤΟΙΧΟΥ ΚΩΝΙΚΟ ΜΕ ΑΝΤΙΡΙΔΑ
DOUBLE GLASS-WALL CONE BRACKET



1000mm

Ρυθμιζόμενο μήκος/Adjustable length **L1300mm/L1100mm/L600mm**

ΚΩΔ./CODE **326**

ΜΠΡΑΚΕΤΟ ΔΙΠΛΟ ΤΟΙΧΟΥ Φ60 ΜΕ ΑΝΤΙΡΙΔΑ
DOUBLE GLASS-WALL BRACKET-Φ60



ΑΝΤΙΡΙΔΑ ΔΙΠΛΗΣ ΑΡΘΡΩΣΗΣ / DOUBLE SIDE ROD

ΚΩΔ./CODE **330**

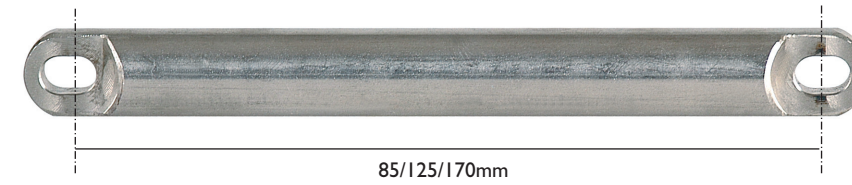

ΚΩΔΙΚΟΣ / CODE

330.85 Φ20 x L85

330.125 Φ20 x L125

330.170 Φ20 x L170

ΑΝΤΙΡΙΔΑ ΠΡΟΣΘΕΤΗ / ADDITIONAL ROD

ΚΩΔ./CODE **334**

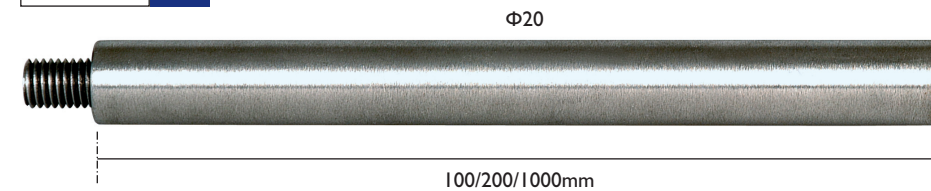

ΚΩΔΙΚΟΣ / CODE

334.100 Φ20 x L100

334.200 Φ20 x L200

334.1000 Φ20 x L1000

ΑΝΤΙΡΙΔΑ ΜΟΝΟΥ ΜΠΡΑΚΕΤΟΥ ΤΟΙΧΟΥ (ΜΕ ΑΣΦΑΛΕΙΑ ΘΕΣΗΣ)
SINGLE BRACKET ROD

ΚΩΔ./CODE **331.170**

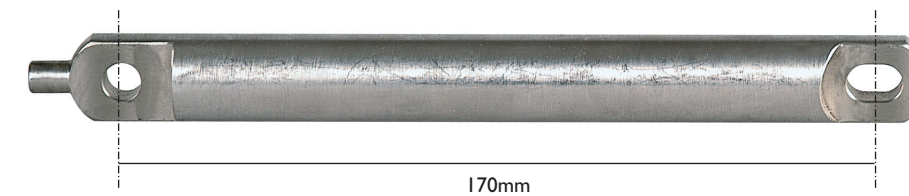

ΑΝΤΙΡΙΔΑ ΔΙΠΛΟΥ ΜΠΡΑΚΕΤΟΥ ΤΟΙΧΟΥ (ΜΕ ΑΣΦΑΛΕΙΑ ΘΕΣΗΣ)
DOUBLE BRACKET ROD

ΚΩΔ./CODE **336.170**

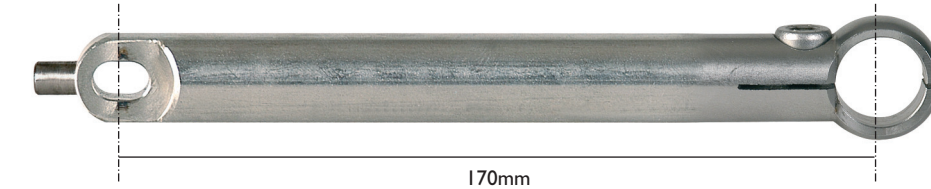

ΑΚΡΟ ΑΝΤΙΡΙΔΑΣ ΔΙΠΛΟΥ ΜΠΡΑΚΕΤΟΥ
DOUBLE END ROD

ΚΩΔ./CODE **332.60**

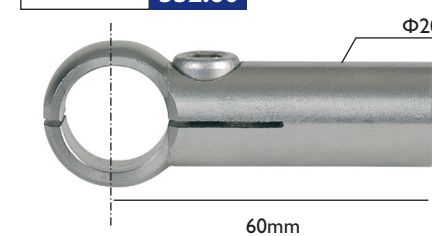

ΑΚΡΟ ΑΝΤΙΡΙΔΑΣ
SINGLE END ROD

ΚΩΔ./CODE **333.60**

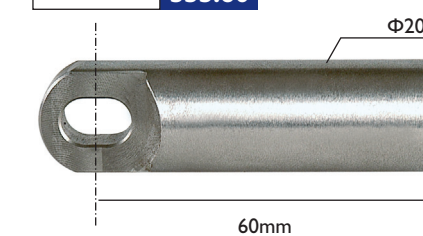

ΣΥΡΟΜΕΝΟ ΚΡΥΣΤΑΛΛΟ MINOX
 SLIDING GLASS MINOX

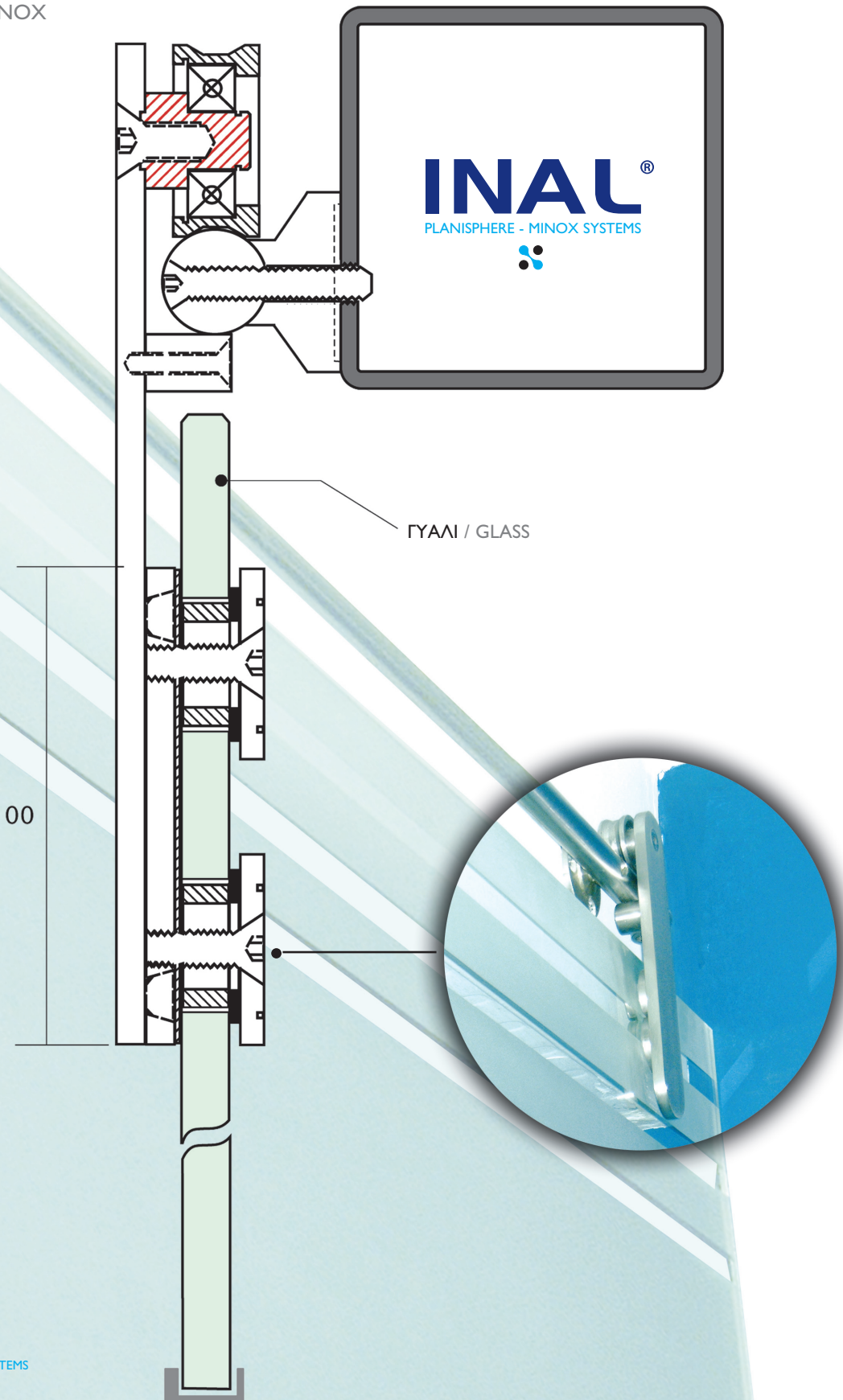

ΣΥΡΟΜΕΝΗ ΓΥΑΛΙΝΗ ΠΟΡΤΑ MINOX / SLIDING GLASS DOOR MINOX

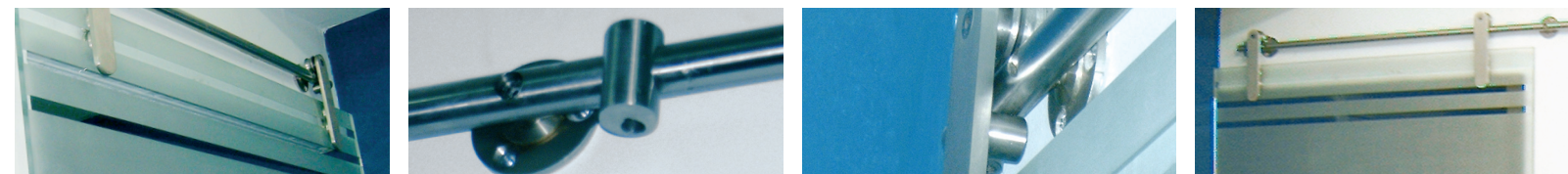
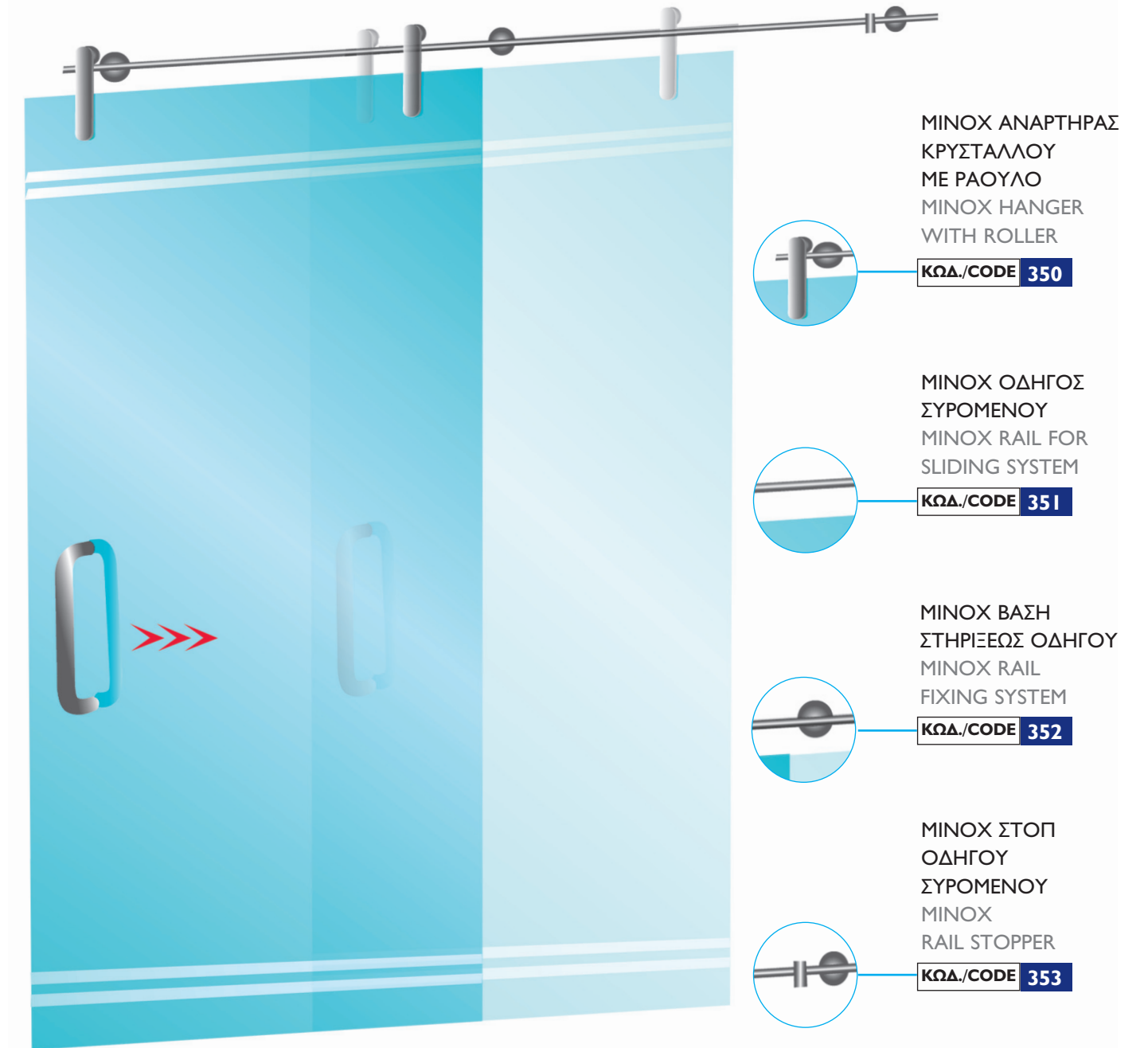



ΕΦΑΡΜΟΓΗ ΓΩΝΙΑΣ ΦΕΓΓΙΤΟΥ INOX ΜΕ ΣΤΗΡΙΓΜΑ ΦΕΓΓΙΤΟΥ ΣΕ ΑΝΟΙΓΟΜΕΝΟ ΥΑΛΟΦΥΛΛΟ
 APPLICATION OF ANGLE PIVOT WITH UPPER SUPPORT AT SWING GLASS DOOR

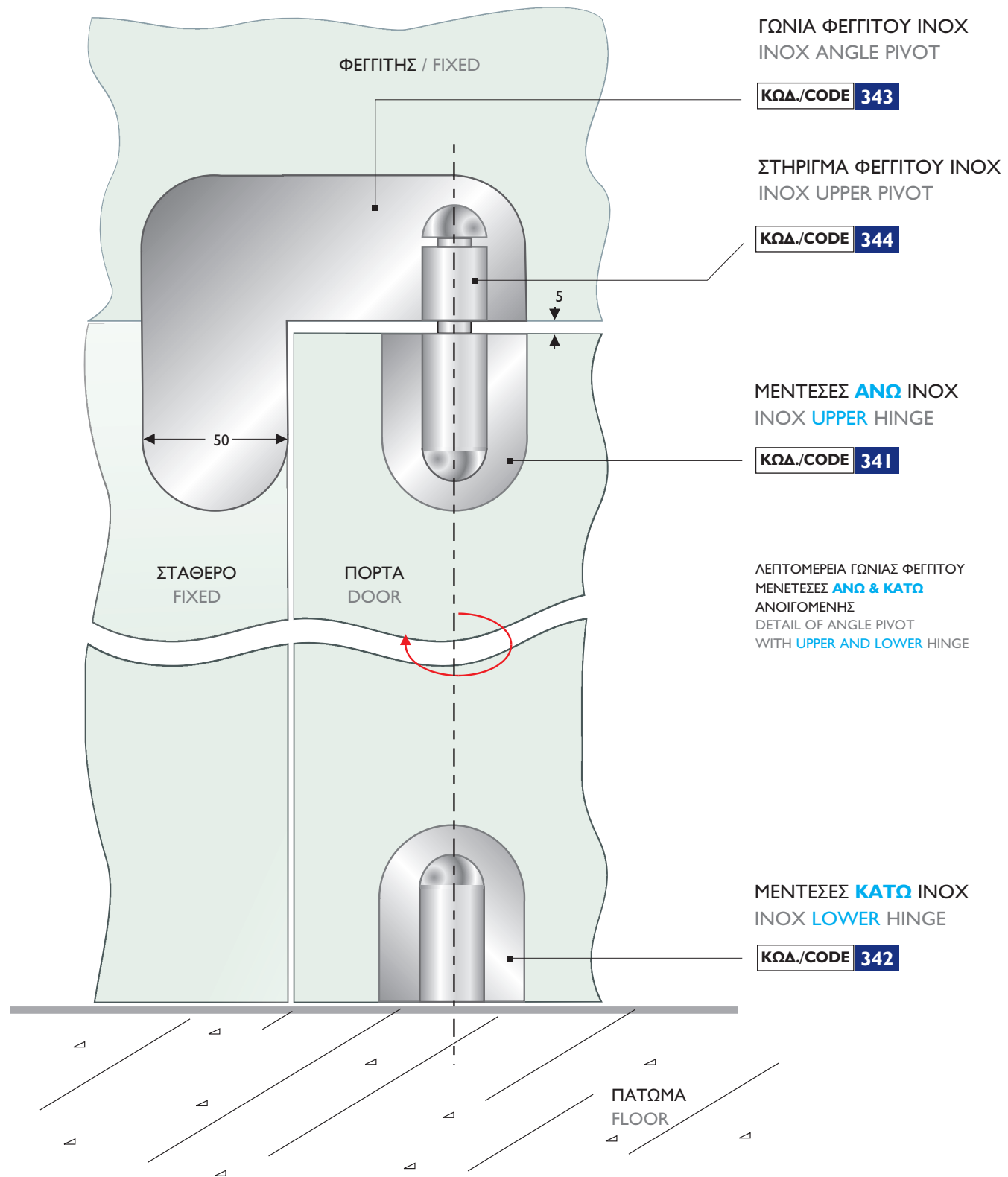

INAL[®]
 PLANISPHERE - MINOX SYSTEMS

ΣΤΗΡΙΓΜΑ PLR ΓΩΝΙΑΚΟ ΔΑΠΕΔΟ-ΓΥΑΛΙ
 ANGLE SUPPORT PLR GLASS-FLOOR

ΚΩΔ./CODE 306



ΕΡΓΑΛΕΙΑ / TOOLS



ΕΞΑΡΤΗΜΑΤΑ / ACCESSORIES

ΓΚΡΟΒΕΡ
GROVER INOX
M16/M14/M12/M10/M8

ΡΟΔΕΛΛΑ/RING INOX
M16/M14/M12/M10/M8

ΒΙΔΑ ΕΞΑΓΩΝΗ
SCREW INOX
M16X50 ΕΩΣ M8X40

ΠΑΞΙΜΑΔΙ/NUT
M16 ΕΩΣ M8

ΔΙΑΚΟΣΜΗΤΙΚΟ
ΠΑΞΙΜΑΔΙ
CUP NUT
M16 ΕΩΣ M8

ΝΤΙΖΑ/ROD
1M/M16 ΕΩΣ M8

ΚΩΔ./CODE 380

ΚΩΔ./CODE 381

ΚΩΔ./CODE 382

ΚΩΔ./CODE 383

ΚΩΔ./CODE 384

ΚΩΔ./CODE 385

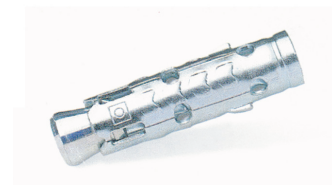

ΜΕΤΑΛΛΙΚΑ ΒΥΣΜΑΤΑ
M6 ΕΩΣ M12



ΒΥΣΜΑΤΑ ΓΑΛΒΑΝΙΣΜΕΝΑ
M6 ΕΩΣ M20



ΒΥΣΜΑΤΑ ΜΕ ΚΩΝΙΚΟ
ΠΑΞΙΜΑΔΙ M6 ΕΩΣ M20



ΧΗΜΙΚΑ ΒΥΣΜΑΤΑ

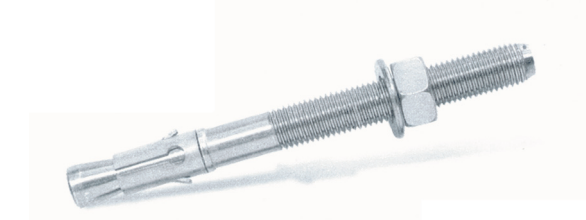

ΑΝΟΞΕΙΔΩΤΑ ΒΥΣΜΑΤΑ M6-M16



ΧΗΜΙΚΕΣ ΠΙΤΙΝΕΣ

ΣΤΕΓΑΝΩΣΗ ΚΡΥΣΤΑΛΛΟΥ-ΤΟΙΧΟΥ ΓΙΑ ΣΤΕΓΑΣΤΡΑ-ΜΑΡΚΙΖΕΣ
GLASS-WALL WEATHER PROOFING

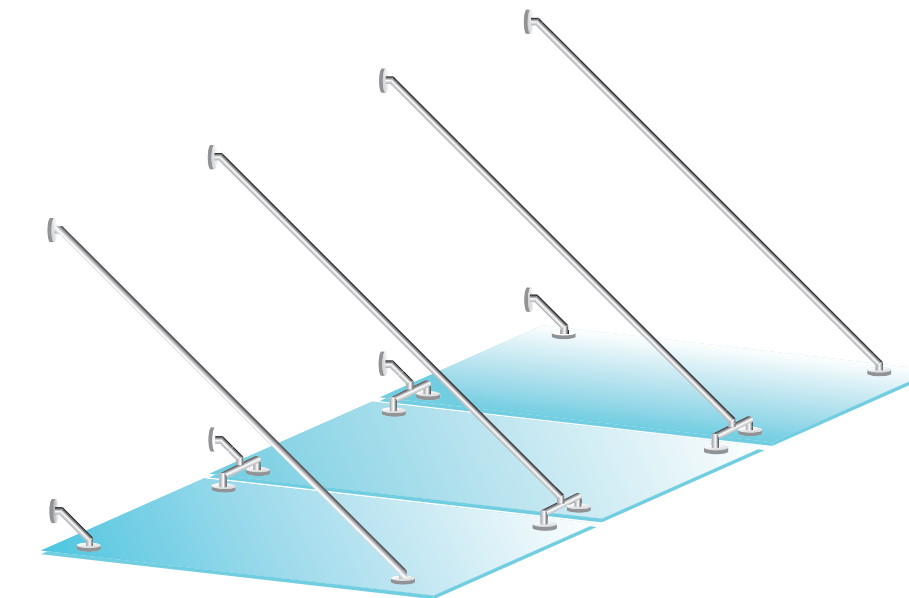
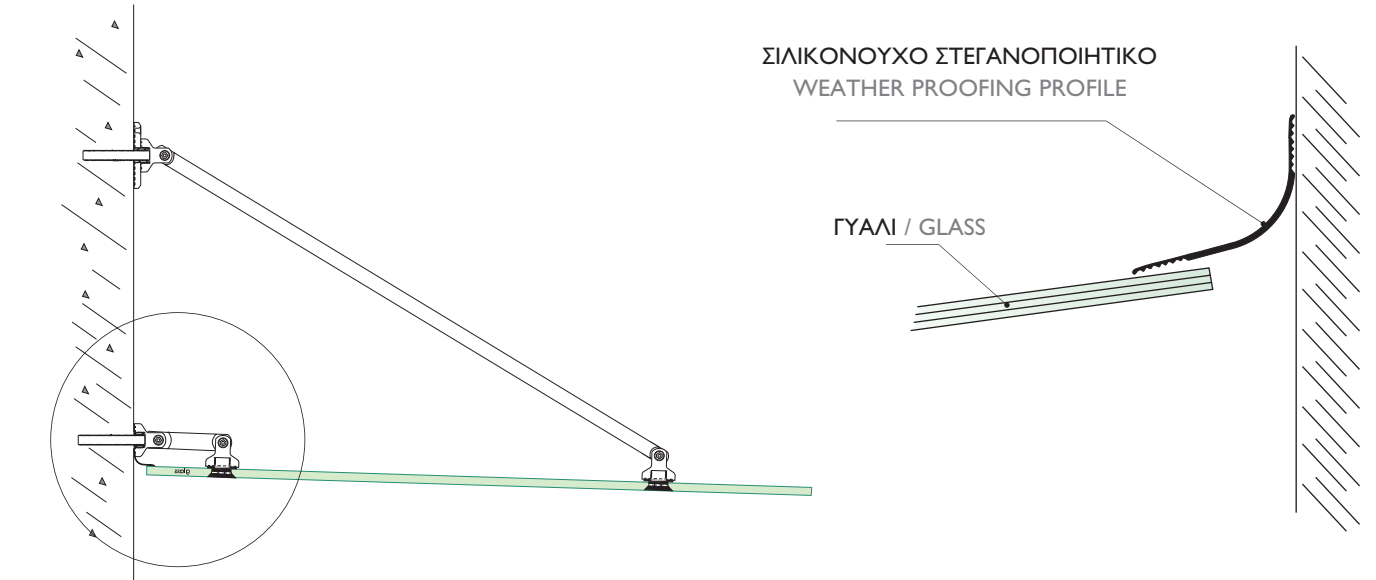

ΣΙΛΙΚΟΝΟΥΧΑ ΣΤΕΓΑΝΟΠΟΙΗΤΙΚΑ
WEATHER PROOFING PROFILES

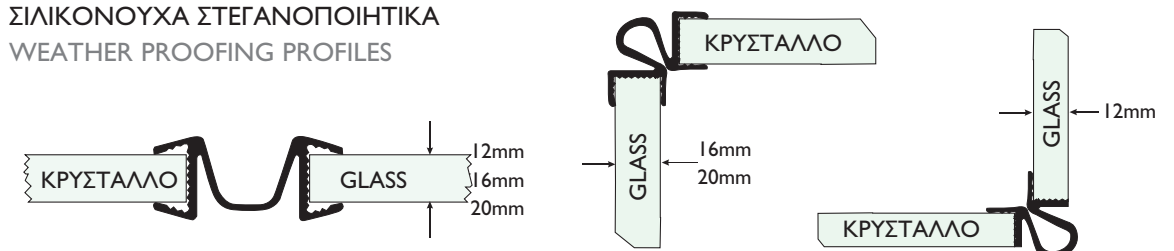



HILTON ATHENS

1



2



3



4



5

1. HILTON ATHENS
2. CAPSIS ΣΥΝΕΔΡΙΑΚΟ ΚΕΝΤΡΟ
3. SATO
- 4-5 PINES HOTEL

INAL[®]
PLANISPHERE - MINOX SYSTEMS

